

DS-1273ZJ-130B



Wall Mounting Bracket for Dome Camera

(with Junction Box)

Features:

- Aluminum alloy material with surface spray treatment
- Design with cable entry hole
- Better water proof design
- Convenient installation coordinating with cap

Dimension:

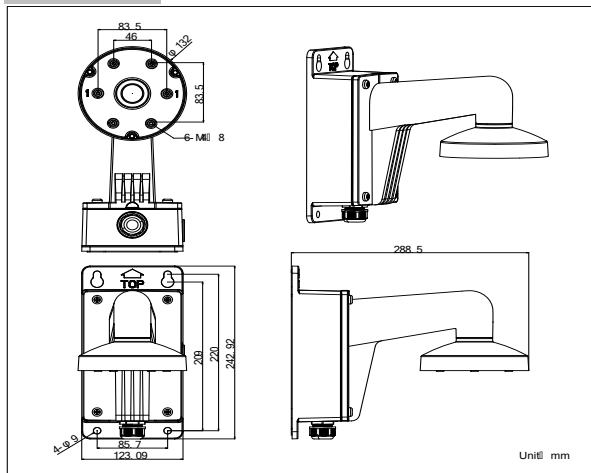

Order Model:

DS-1273ZJ-130B

Parameter:

Model	DS-1273ZJ-130B
Parameters	Wall Mounting Bracket for Dome Camera (with Junction Box)
Appearance	Hikvision White
Range of Application	Suitable for dome camera wall mounting
Material	Aluminum Alloy
Dimension	Φ 132 × 242.9 × 288.5mm
Weight	1475g

Notice:

- Pay attention to the color matching when select bracket
- The bracket should be installed on flat wall
- The wall must be capable of supporting over 3 times as much as the total weight of the camera and the mount.
- The maximum load capacity of the bracket is 4.5KG

Model Suitable:

DS-2CD7X3PF(NF)-E(I)(Z), DS-2CD793PFWD-E(I)(Z)
 DS-2CD793NFWD-E(I)(Z), DS-2CD7X4FWD-E(I)(Z)
 DS-2CD7XXF-E(I)(Z), DS-2CD783F-EP
 DS-2CD4112F-(I), DS-2CD4112FWD-(I)
 DS-2CD4124F-(I), DS-2CD4132FWD-(I)

Installation Step:

- ① Choose the appropriate wall to fix the junction box

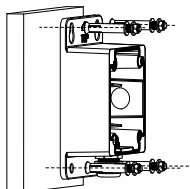

- ② Wiring through waterproof stopper

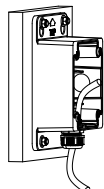

- ③ Install bracket to junction box; wiring and screw up

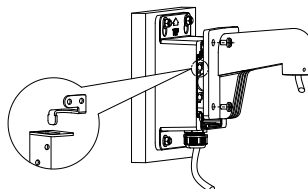

- ④ Fix cap to bracket and fix with fastening screw; wiring

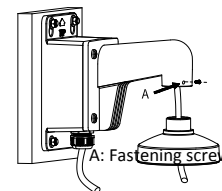

- ⑤ Take adaptor from the case of dome camera

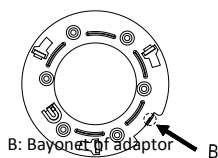

- ⑥ Check the hole site and fix adaptor to cap

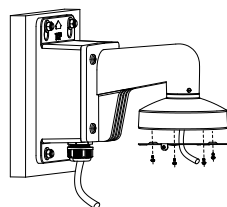

- ⑦ Wiring and fix dome camera to adaptor

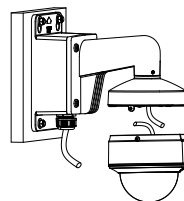

- ⑧ Rotate the dome camera moderately and screw up. Installation complete.

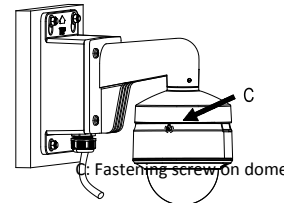

Note: The actual bracket may vary from the picture above.