

PFA114

Mount Adapter



Features

- Material: Aluminum
- Mount Adapter
- Neat & Integrated design

Specifications

Model	PFA114
General	
Material	Aluminum
Dimension (W x H x D)	Φ60mm x 50mm
Pipe Thread	G1 ₁ / 2"
Operating Temperature	-40°C ~60°C
Humidity	0~90% RH
Load Bearing	N/A
Weight	0.25Kg
Applicable Model	Please see "Accessory Selection"

PFA114

Dimensions (mm)

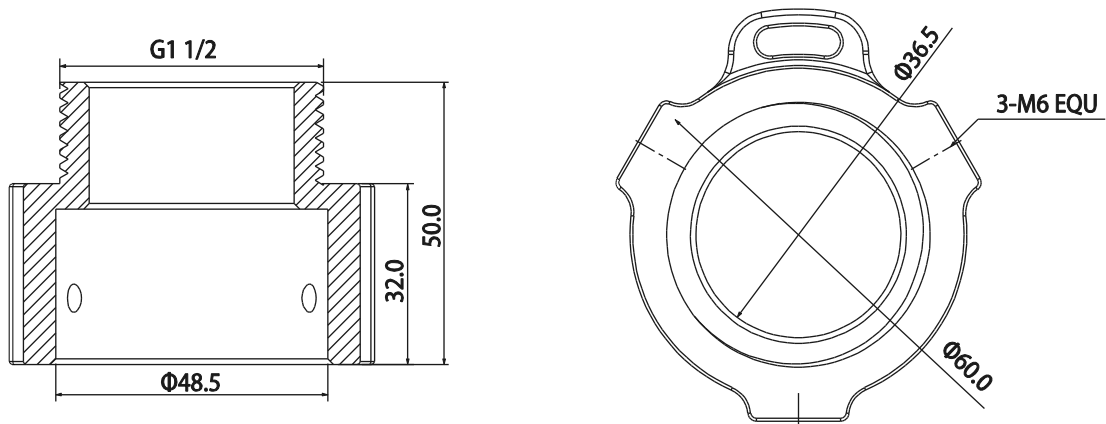

Application

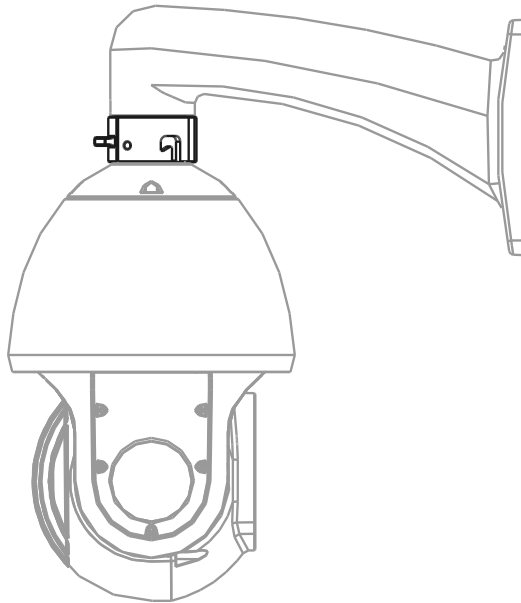

Dahua Technology Co., Ltd.

1199 BinAn Road, Binjiang District, Hangzhou, China

Tel: +86-571-87688883

Fax: +86-571-87688815

Email: overseas@dahuatech.com

www.dahuasecurity.com

*Design and specifications are subject to change without notice.

© 2013 Dahua Technology Co., Ltd.